

TC-14B3R/N Operating Instruction

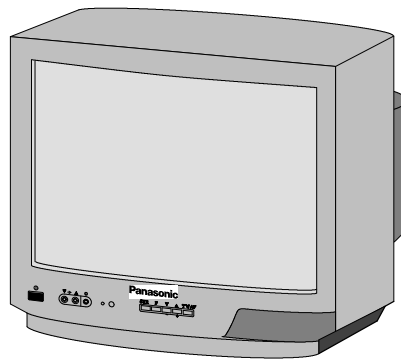

Panasonic



TC- 14B3R/N

(U.K. Standard)

Please read these instructions completely before use and retain them for future reference.

Dear Panasonic Customer,

Welcome to the Panasonic family of customers. We hope that you have many years of enjoyment from your new colour television. The best way to understand the features of this television is to read this book thoroughly, before operating the set.

CONTENTS



- Warnings and Precautions 3
- Accessories 4
- Fitting Remote Control Batteries 4
- Installation and Set- up 5
- Location of Controls 7
- Menu Operation 8
- Audio / Video Connections 10
- VCR and Satellite Receiver Installation 11
- Trouble- shooting 12
- General Information 12
- Specifications 13
- Scart Terminal Information 13

WARNINGS AND PRECAUTIONS

- This T.V. is designed to operate on A.C. 220 - 240V, 50Hz and is capable of receiving the PAL I transmission standard.
- Do not expose this TV set to rain or excessive moisture.
- **WARNING: HIGH VOLTAGE !**
Do not remove the rear cover, there are no user serviceable parts inside.
- Avoid exposing the TV set to direct sunlight or other sources of heat.
- Remove the mains plug from the wall socket when the TV set is not to be used for a prolonged period of time. Do not pull the power cable to remove the mains plug from the socket, always remove it by the plug.
- **CABINET AND PICTURE TUBE CARE**
Remove the mains plug from the wall socket. The cabinet and picture tube can be cleaned with a soft cloth moistened with mild detergent and water. Do not use solutions containing benzol or petroleum. TV sets can produce static electricity, care must be taken whenever touching the TV screen.
- Adequate ventilation is essential to prevent failure of electrical components. We recommend that a gap of at least 5cm is left all around this TV even when it is placed inside a cabinet or between shelves.

FOR YOUR SAFETY PLEASE READ THE FOLLOWING CAREFULLY

This appliance is supplied with a fitted three pin mains plug for your safety and convenience. A 5 amp fuse is fitted in this plug. If the fuse is replaced then the replacement fuse must be 5 amp rated and should be approved by ASTA or BSI to BS1362.

Check for the ASTA mark  or the BSI mark  on the body of the fuse.

If the fitted plug has a removable fuse cover you must ensure that it is refitted when the fuse is replaced. If you lose the fuse cover the plug must not be used until a replacement cover is obtained.

Replacement fuse covers can be purchased through your local Panasonic dealer.

The plug fitted to this appliance incorporates a mains filter circuit. If this is removed or replaced with a non- filtered mains plug this television will no longer meet the European standards for Electromagnetic Compatibility (EMC). If the fitted plug is unsuitable for the socket outlet in your home an appropriate adapter should be used.

Nonetheless, if the fitted plug is replaced, the fuse should be taken out and the cut- off plug disposed of safely. There is danger of severe electrical shock if the cut off plug is inserted into any 13amp socket.

If a new plug is to be fitted please observe the wiring code as shown below.
If in any doubt please consult a qualified electrician.

How to replace the fuse :

Lift out the removable fuse compartment with a screwdriver and replace the fuse, then refit securely into the mains plug.

IMPORTANT :- The wires in the mains lead of this appliance are coloured in accordance with the following code :-

BLUE : NEUTRAL

BROWN : LIVE

As the colours of the wires in the mains lead of this appliance may not correspond to the markings identifying the terminals in your plug, proceed as follows :-

1. The **BLUE** wire must be connected to the terminal marked 'N' or coloured black.
2. The **BROWN** wire must be connected to the terminal marked 'L' or coloured red.

IMPORTANT NOTE : Under no circumstances should either of these wires be connected to the Earth terminal of the three pin plug, marked with the letter 'E' or the earth symbol ().

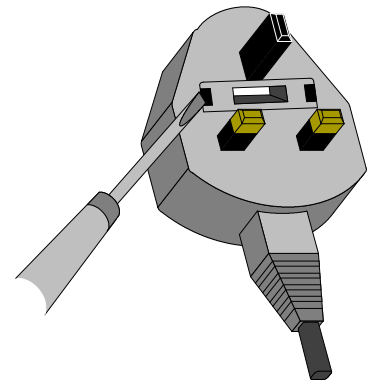

Important Note :
The layout of the mains plug used may differ from this illustration.

ACCESSORIES

Check that you have the accessories and items shown

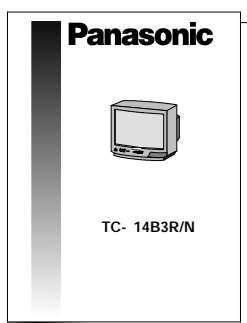

Operating Instruction book



TV Guarantee

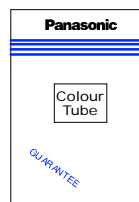

CRT Guarantee



Questionnaire

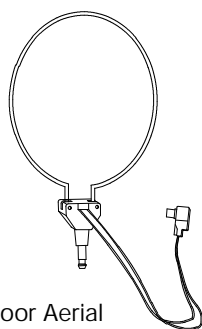

Indoor Aerial
TSA8E003

Remote Control Transmitter
EUR501302



Batteries for the
Remote Control Transmitter.
(2 x R6 (UM3) size)

FITTING REMOTE CONTROL BATTERIES

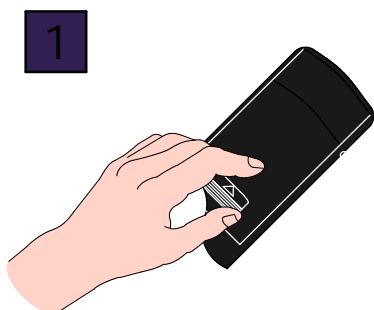

Slide off the battery cover



Insert batteries - note correct polarity



Replace the cover

- Make sure that the batteries are fitted the correct way round.
- Do not mix old batteries with new batteries. Remove old, exhausted batteries immediately.
- Do not mix different battery types, i.e. Alkaline and Manganese. Do not use rechargeable (Ni- Cd) batteries.

INSTALLATION AND SET- UP

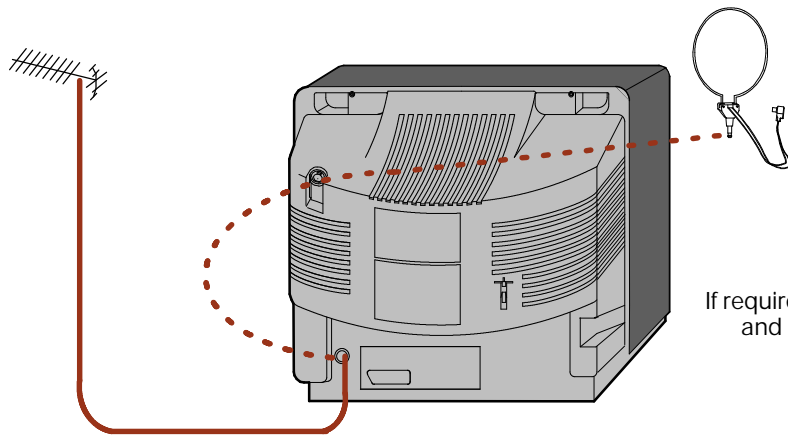

1

TV only

Connect Aerial co- axial cable direct to TV RF IN socket.

If required, insert the indoor aerial into the case socket and connect the cable to the TV RF IN socket.

OR

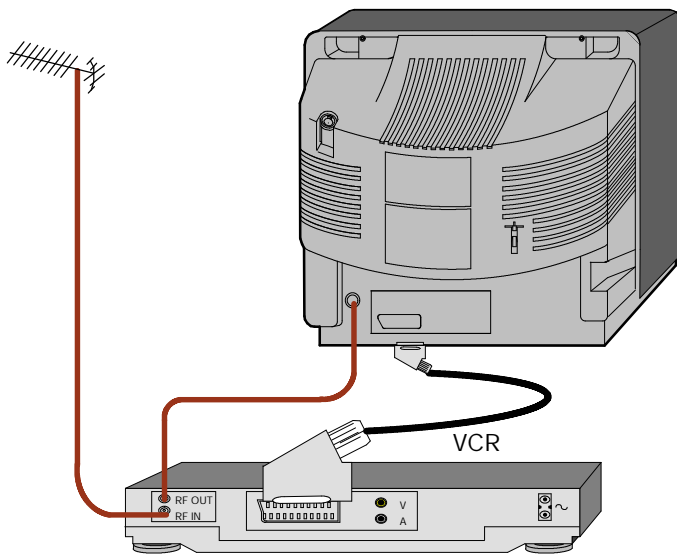

USING A VCR

Connect aerial co- axial cable to RF Input socket of VCR and a RF co- axial cable from VCR RF Out socket to TV RF IN socket.

The VCR can also be connected to the TV using a SCART to SCART lead.

Further details of Audio/ Video connections can be found on page 10.

OR

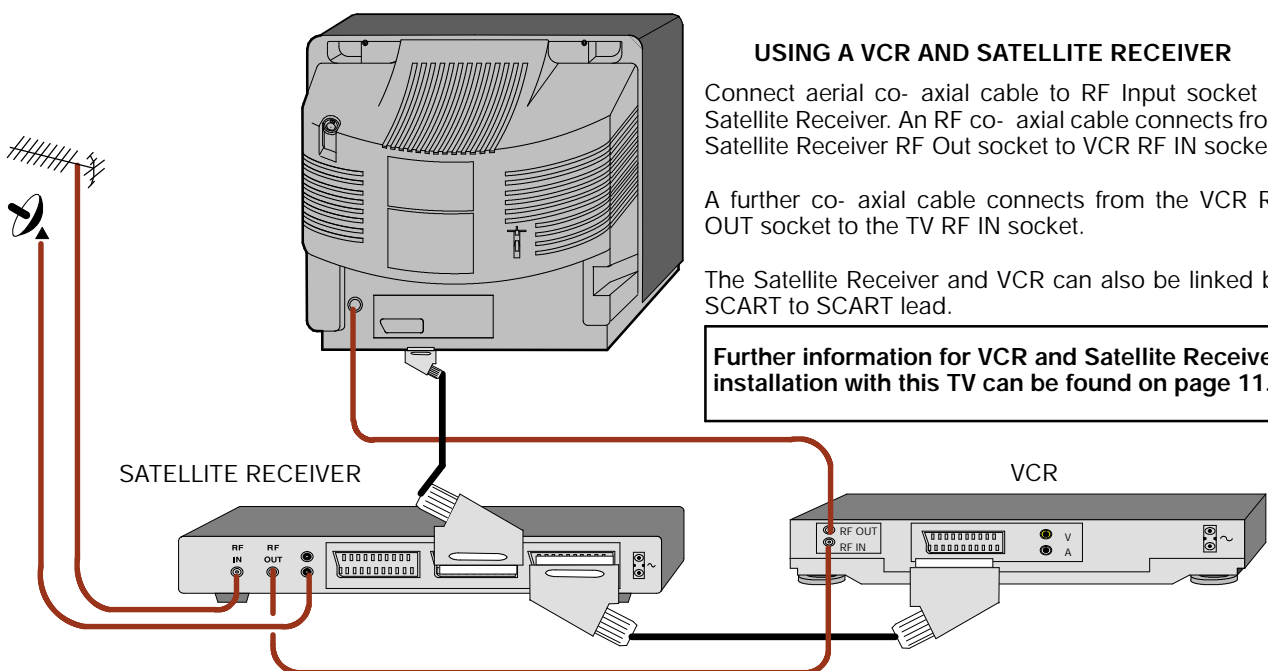

USING A VCR AND SATELLITE RECEIVER

Connect aerial co- axial cable to RF Input socket of Satellite Receiver. An RF co- axial cable connects from Satellite Receiver RF Out socket to VCR RF IN socket.

A further co- axial cable connects from the VCR RF OUT socket to the TV RF IN socket.

The Satellite Receiver and VCR can also be linked by SCART to SCART lead.

Further information for VCR and Satellite Receiver installation with this TV can be found on page 11.

Ancillary equipment and leads are not supplied.

INSTALLATION AND SET- UP

2

Switch ON your VCR (if connected).
Switch ON your Satellite Receiver (if connected).
Plug the TV into a mains socket and switch ON.
Programmes will appear immediately if your dealer has already tuned the TV for you.

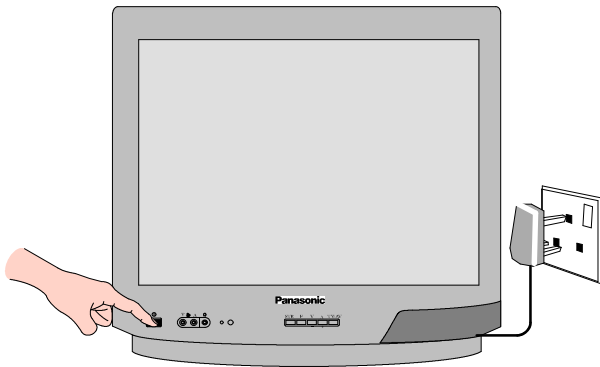

3

If the TV has not been tuned for you then **Auto setup** will begin. TV stations will be located and stored.

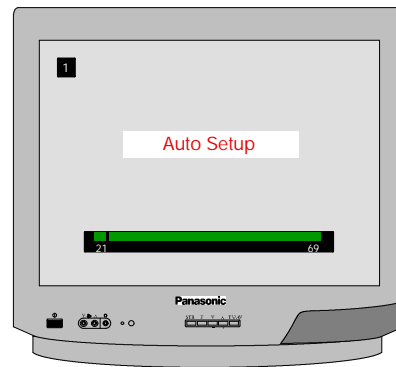

4

The first available channel will be displayed.

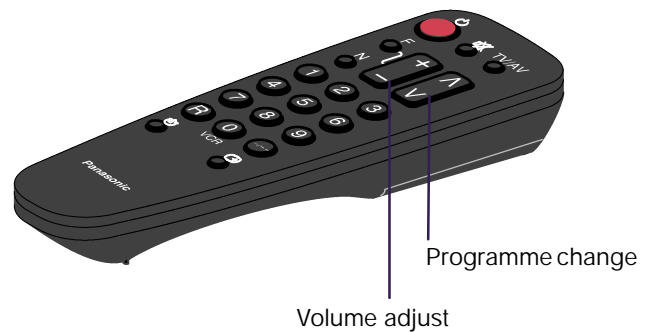

The TV stations will be stored in the order that they have been found, if the order is not to your preference it can be rearranged. Refer to the Tuning menu Swap feature - see page 9 for details.

IT IS IMPORTANT that you only use TV programme position '0' to view your VCR. If your VCR picture does not appear on programme position '0' (the VCR position), it will be necessary to either adjust the RF channel of the VCR (refer to your VCR operating instructions) or adjust the tuning of the TV's programme "0" or both until the RF output channel of the VCR is received, refer to page 11 for guidance.

LOCATION OF CONTROLS

On Screen Displays

Menu Title
 Cursor Bar
 Sub Menu
 Commands :
 A guide to the various options available when in On Screen Menu operations.

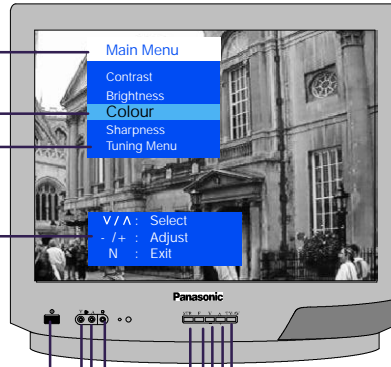

Front Panel Controls

Mains Power On/Off switch
Note :
 If the power supply is interrupted e.g. mains plug removed from socket outlet, then the red light indicating standby may be on for a short period of time.
 RCA Audio/Video sockets
 Headphone socket

TV / AV
 Switches between TV and AV modes
 ? / - , ? / +
 Programme up / down.
 When a function is already displayed, allows adjustment of the function.
 F
 Selects a function from :
 Volume, Contrast, Brightness, Colour, Sharpness and Manual Tuning.
 STR
 Stores tuning and other function settings

Remote Control keys

Function Select
 Press to display the On Screen Menus (Page 8)
 Restores the levels previously set with STR (TV front panel)
 Standby On/Off
 Sound mute On/Off
 Switches between TV and AV modes (Page 10)
 Channel up/down and Menu option select
 Adjusts currently selected function. Adjusts the volume if no function is selected
 Numeric keys for programme change
 Switches between the current and last programme positions
 Off timer
 Press to select from 30, 60 or 90 minutes.
 Select 0 to cancel Off timer.
 Status :
 Displays programme position
 Selection of programmes
 10- 70 using numeric keys

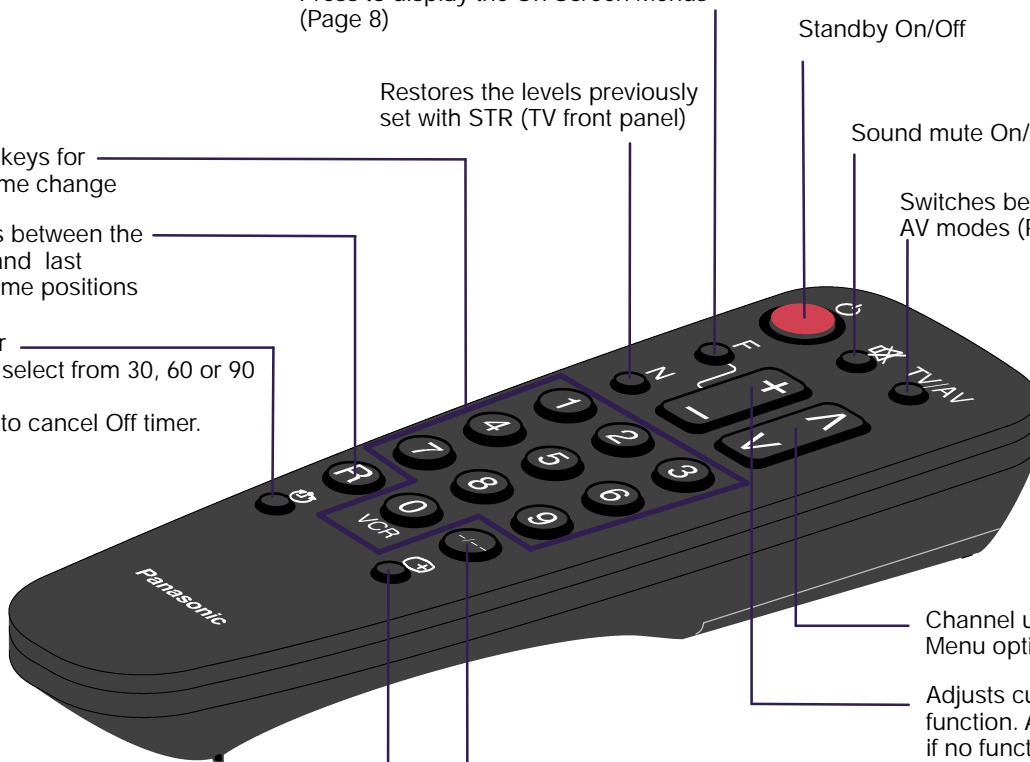

MENU OPERATION

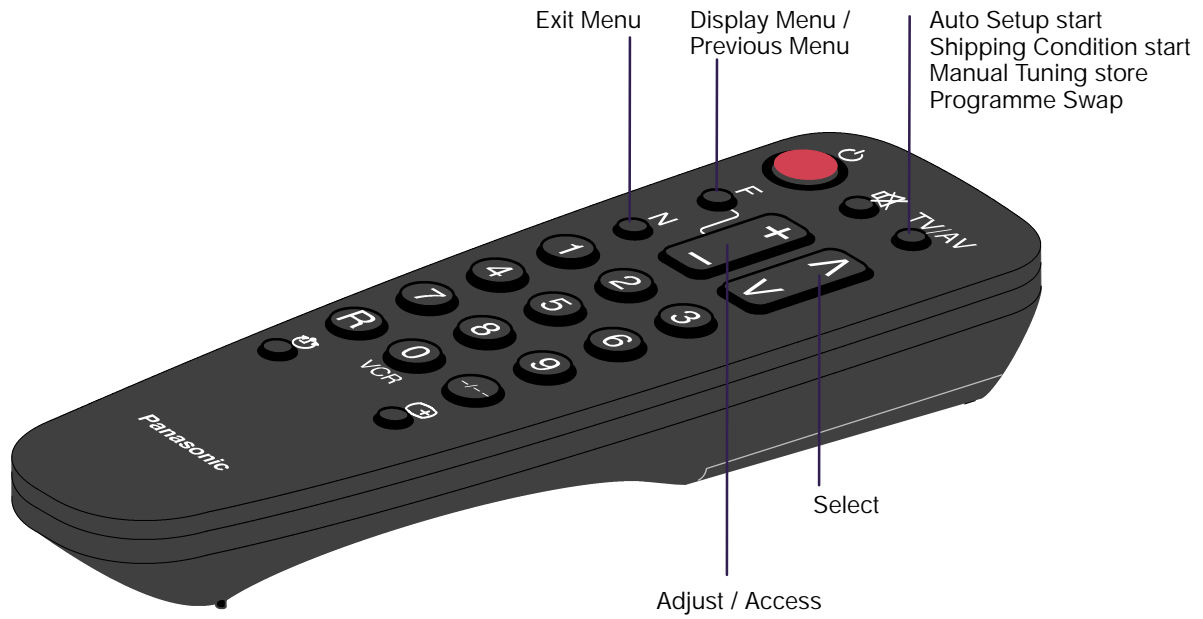

Main Menu

Contrast

Brightness

Colour

Sharpness

The Contrast, Brightness, Colour and Sharpness may be altered to suit the viewing conditions and personal preferences.

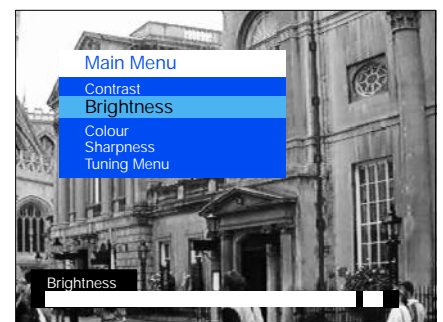
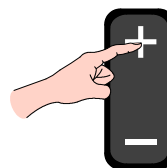
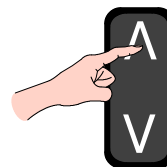
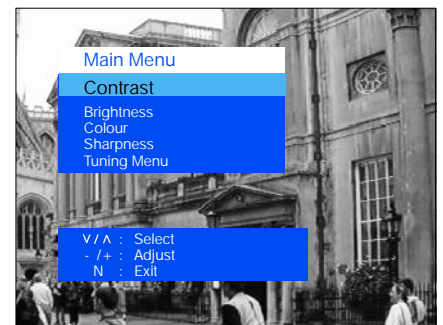
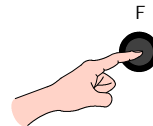

MENU OPERATION

Tuning Menu

The Tuning menu provides access to both manual and automatic tuning menus.

Auto Setup

The Auto Setup menu allows you to automatically retune the TV, particularly useful if you move to an area that is served by a different transmitter.

Manual Tuning

The Manual tuning menu allows individual programme positions to be tuned manually.

Shipping Condition

Allows you to clear all tuning information and reset all control levels back to the factory settings.

Swap

If the programme order after Auto Setup is not to your preference you can swap programmes between positions.

An example could be for regional variations, e.g. BBC1 Wales and BBC1 West, where you may want to swap them so that BBC1 West appears on programme position 1.

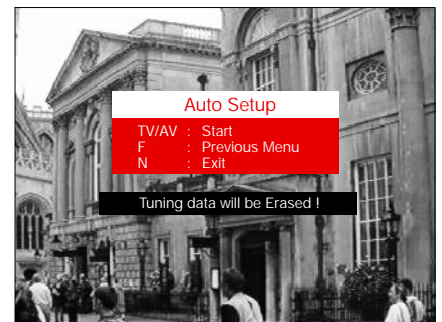
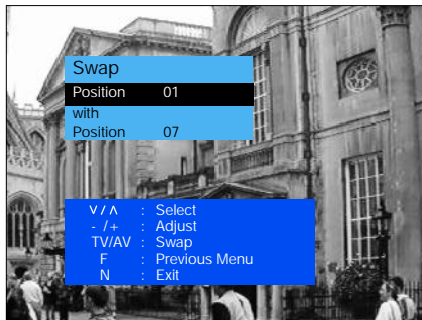
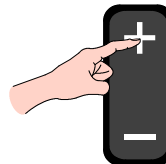
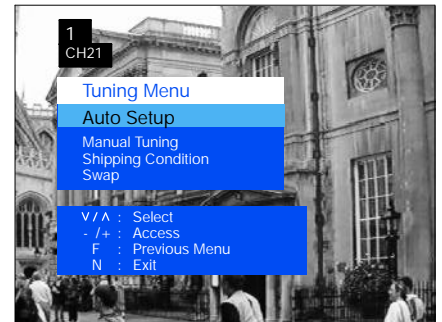
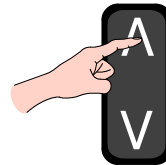
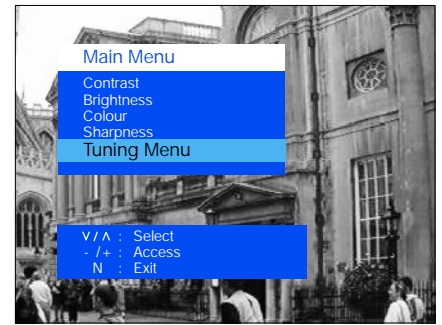
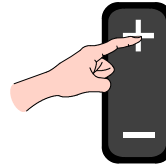

Manual Tuning (front panel of the television)

The stations may also be manually tuned using the controls on the front of the television.

Press the F key (Front panel) until "Manual Tuning" is reached. Press - or + to access "Manual Tuning".

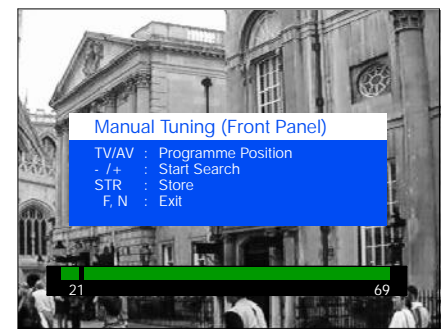
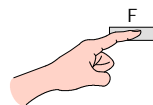

AUDIO / VIDEO CONNECTIONS (FRONT OR REAR)

AV (Audio / Video) is a dedicated input for VCR's, Satellite Receivers and other Audio / Video equipment. To ensure correct display of an Audio / Video input, it is necessary to first select AV mode using the TV/AV key on the remote control or front panel controls.

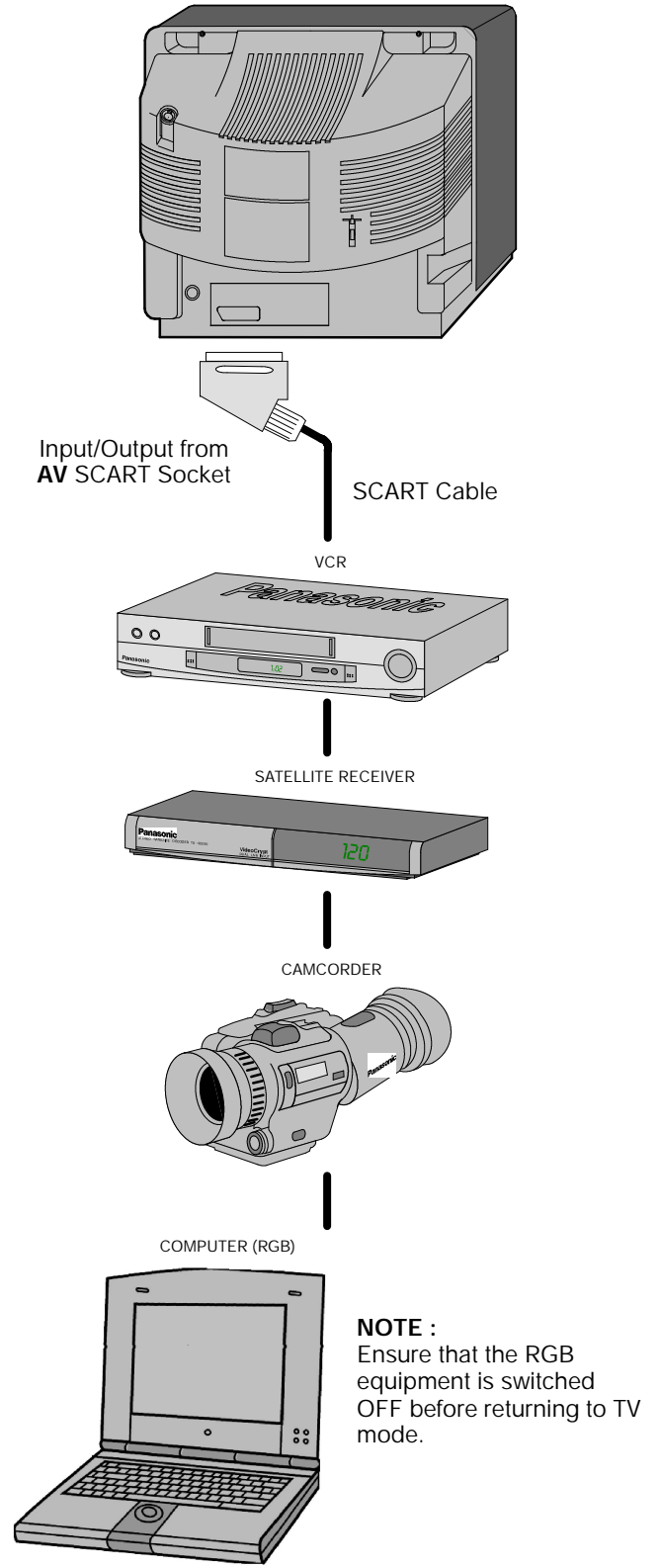
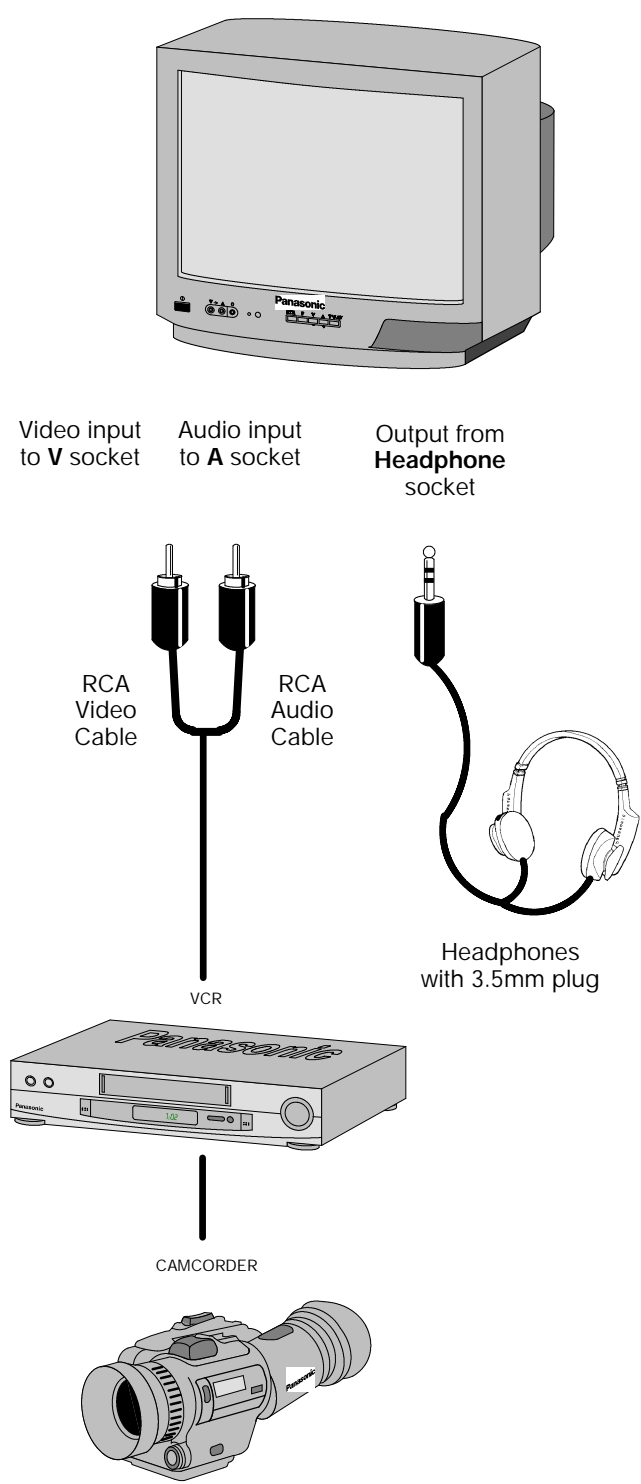

Ancillary equipment and cables shown are not supplied with this TV set.
Do not connect a computer with TTL output (5V) to this TV set.
The TV's speaker will be automatically disconnected whilst the headphones are connected.
Do not connect front and rear AV inputs simultaneously, as the sound and pictures will be mixed.

VCR AND SATELLITE RECEIVER INSTALLATION

Your new TV is supplied with programme position '0' set to receive an RF signal from a VCR.

However, if for some reason the VCR is tuned to a different RF channel then you will not receive any picture or sound from the VCR on programme position '0' of the TV. It will be necessary to either adjust the RF channel of the VCR or to adjust the tuning of the TV's programme position '0' or both until the RF output channel of the VCR is received.

It is intended that this advice is used in conjunction with the instruction books for your ancillary equipment.

TO TUNE YOUR VCR TO THE TV

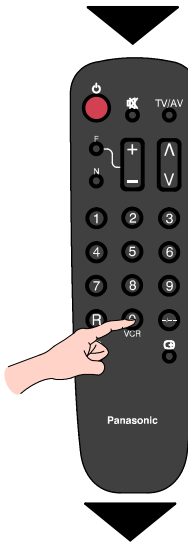
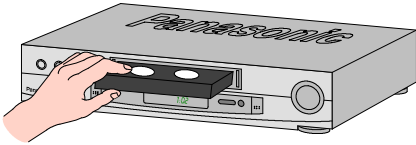

RF CHANNEL ADJUST

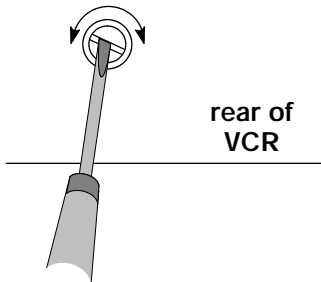

rear of VCR

Note :
Some VCR's are capable of adjusting their RF channel via their remote control unit.



Insert recorded tape and select playback

Set TV to programme position '0' VCR

Adjust tuning

Operation completed

See below for installation of VCR and Satellite Receiver

TO TUNE YOUR TV TO THE VCR

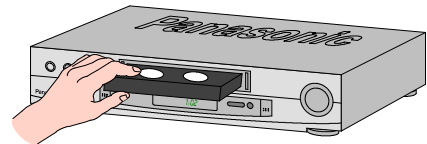

Access the Manual tuning menu as detailed on page 9.

Programme position is displayed top left of screen

? ? To select programme position '0' (VCR)
- + To start search for VCR playback

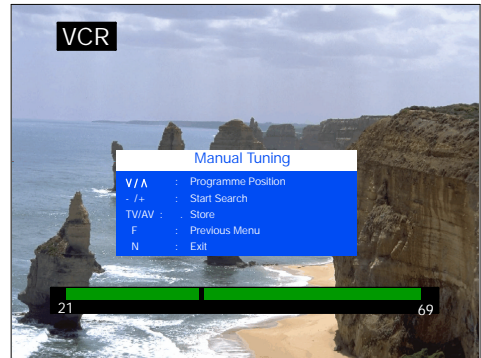

TV/AV To store position

N To return to viewing screen



If you are going to use a Satellite Receiver and a VCR, it is important, to avoid tuning problems, that they are both tuned to output their signals on different channels. For example, if your VCR is tuned to output channel 32, your Satellite Receiver could be set to output channel 34. Refer to your Satellite Receiver and VCR instruction books for precise tuning information.

TROUBLE- SHOOTING

Before calling for service, determine the symptoms and make a few simple checks as shown below. For service please contact your local Panasonic dealer quoting the model number and serial number (both are located at the rear of the TV).

Symptoms		Checks
Picture	Sound	
Snowy Picture or Multiple Images	Noisy Sound or Normal Sound	Aerial location, direction or connection
Interference	Noisy Sound	Electrical appliances, vehicles, fluorescent lights
Normal Picture	Noisy or No Sound	Volume level or sound muted
No Picture	No Sound	Not plugged into A.C. outlet, not switched on picture / sound controls set at minimum levels
No Colour	Normal Sound	Colour controls set at minimum levels
Scrambled	Normal or Weak Sound	Retune channel(s)

GENERAL INFORMATION

Sleep Feature

If the set is not switched off when the TV station stops transmitting, it will automatically go to standby mode after 30 minutes. This function will not operate when in AV mode.

Last Position Memory

Certain functions have a last position memory, i.e. the setting at the time of switch off will be the setting used when the receiver is switched on again:

Programme position	Colour	Volume
Contrast	Brightness	Standby
Sharpness	Status	

TV Games / Home Computers

Extended use of TV games or home computers with any television set can cause a permanent 'shadow' on the screen. This type of irreversible picture tube damage can be limited by observing the following points :

- Reduce the brightness and contrast levels to a minimum viewing level.
- Do not operate the television set for a continuous period of time while using TV games or home computers.

This type of picture tube damage is not an operating defect and as such is not covered by the Panasonic warranty.

Panasonic (U.K.) Ltd
Willoughby Road,
Bracknell,
Berks.
RG12 8FP